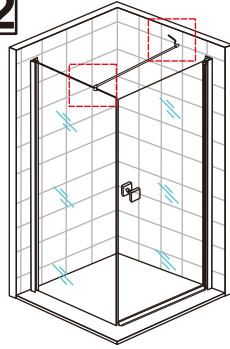
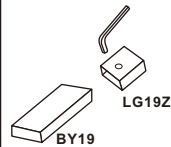
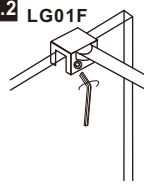
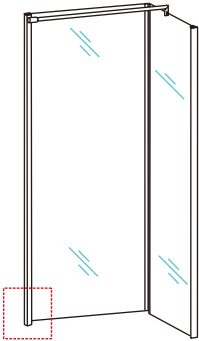

12**12.1**

6LHP17

**12.2**

LG01F

**13****14**

SILIKON

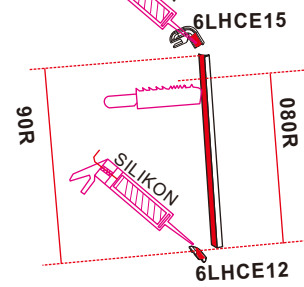
SILIKON!**14.1**

6LHCE15

14.2

6LHCE12

**13.1**

6LHP17

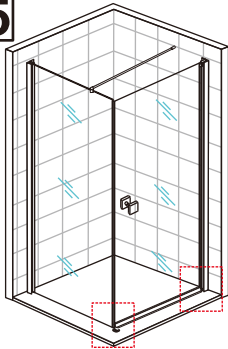
15**15.1**

6LHCE15

15.2

6LHCE12

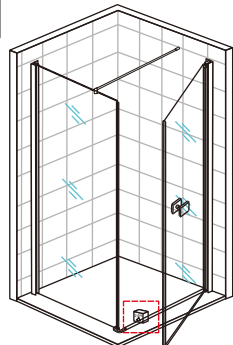
16**16.1**

24H

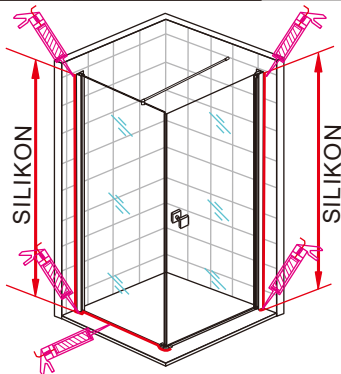
17**17.1**

SILIKON

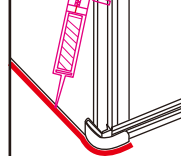
17.2**OSTROŻNIE! SZKŁO HARTOWANE!**

Szko hartowane jest dużo bardziej odporne na zginanie i zmiany temperatur niż tradycyjne. Jest to szkło bezpieczne, gdyż po przekroczeniu jego wytrzymałości ulega rozbiciu na wiele drobnych kawałków, co minimalizuje ryzyko poważniejszego zranienia. Uszkodzona krawędź, zarysowanie powierzchni bądź zbyt silne naprężenie (np. spowodowane nieprawidłowym montażem) może spowodować rozbicie szyby (popęknięcie). W zależności od wielkości ubytku lub siły naprężenia może to nastąpić bezpośrednio przy montażu bądź nawet po kilku miesiącach. Podczas montażu kabiny szczególnie należy dbać o to, aby krawędzie tafli szkła nie stykały się bezpośrednio z twardymi powierzchniami (np. nie należy opierać tafli szkła na kaflach- szczególnie narożników - podczas montażu). Krawędzie szkła powinny być zabezpieczone ochronnymi narożnikami lub ostonami z tworzywa sztucznego w trakcie wyjmowania z opakowania oraz montażu.

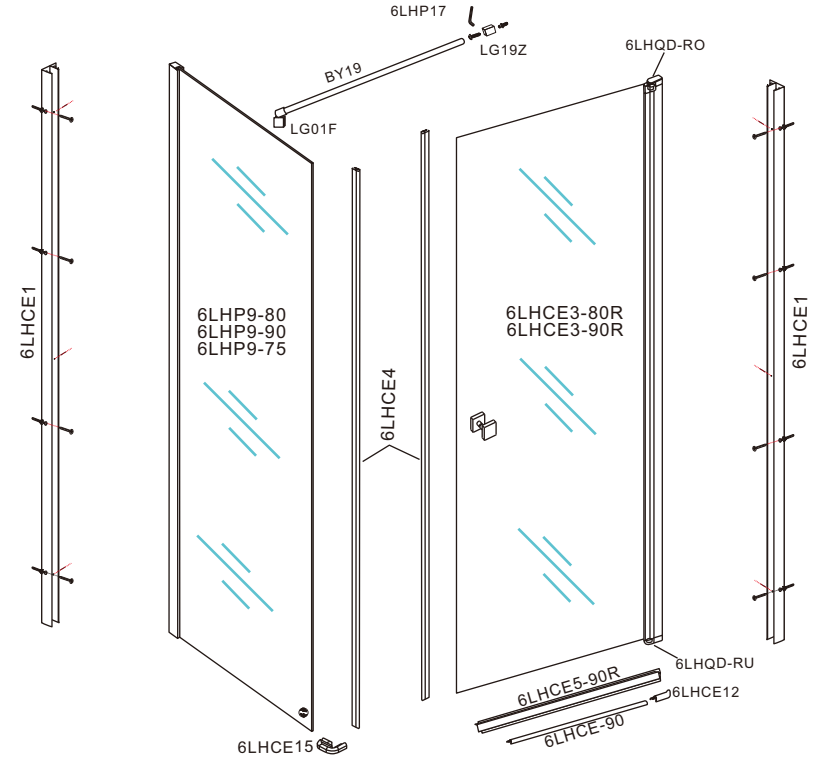
B

CSKU09

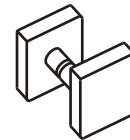

1X

LG19Z



6LHCE12

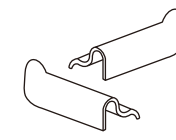

1X

6LHCE15

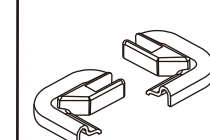

1X

BY19



1X

LG01F



1X

6CE

6CE8

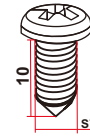

6X

6CE9

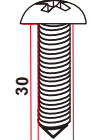

9X

6CE11

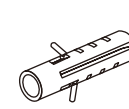

9X

6LHP17

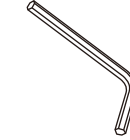

1X

6LHQP-RO



1X

6LHQP-RU

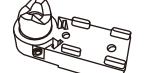

1X

